

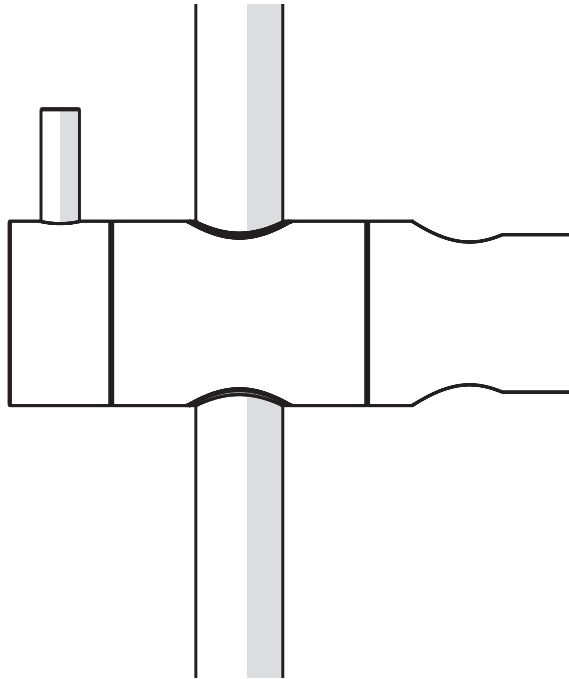

P A R
TAPS



Handshower Slider Adjustments

Installation Guide

Handshowers on Wall Bracket

For Burj, Oracle, Lugano

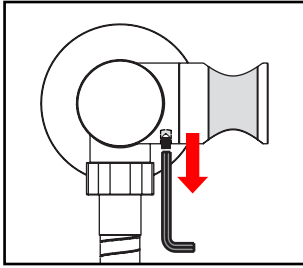

1. Loosen the grub screw inside the slider with an Allen Key

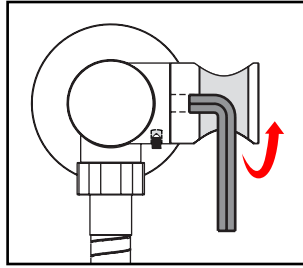

2. Tighten the screw inside the slider

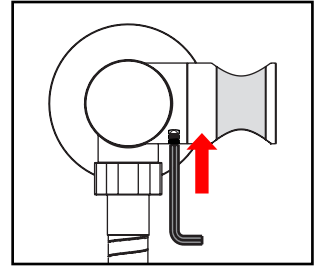

3. Retighten the grub screw until firm fit

Product Depictions in this Guide

For illustrative purposes, Lugano products have been featured in this guide.

There will be variations in appearance between this guide and products ranges, but installation remains identical.

Handshowers on Rail

For Tudor & Bell

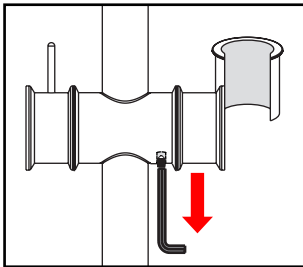

1. Loosen the grub screw inside the slider with an Allen Key

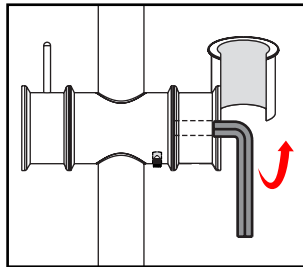

2. Tighten the screw inside the slider

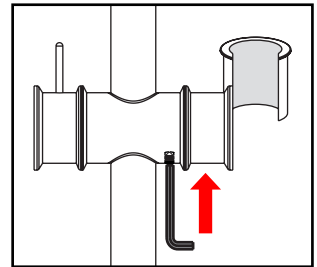

3. Retighten the grub screw until firm fit

Product Depictions in this Guide

For illustrative purposes, Tudor products have been featured in this guide.

There will be variations in appearance between this guide and products ranges, but installation remains identical.

Wall Shower Divetor High Rise

For Lugano

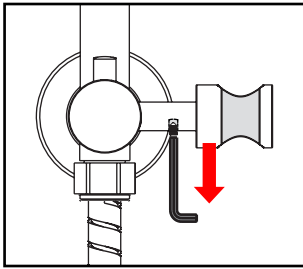

1. Loosen the grub screw inside the slider with an Allen Key

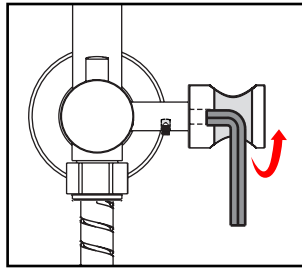

2. Tighten the screw inside the slider

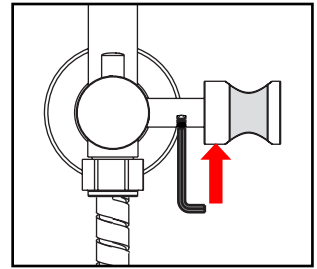

3. Retighten the grub screw until firm fit

Handshowers on Rail

For Burj, Oracle, Lugano

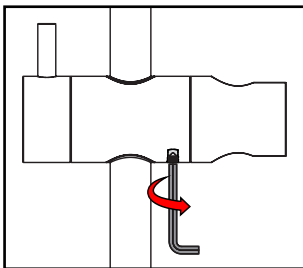

1. Retighten the grub screw inside the slider

Product Depictions in this Guide

For illustrative purposes, Lugano products have been featured in this guide.

There will be variations in appearance between this guide and products ranges, but installation remains identical.



P A R
TAPS



www.partaps.com



[/ParTapsPtyLtd](https://www.facebook.com/ParTapsPtyLtd)



[@par_taps](https://www.instagram.com/par_taps)