

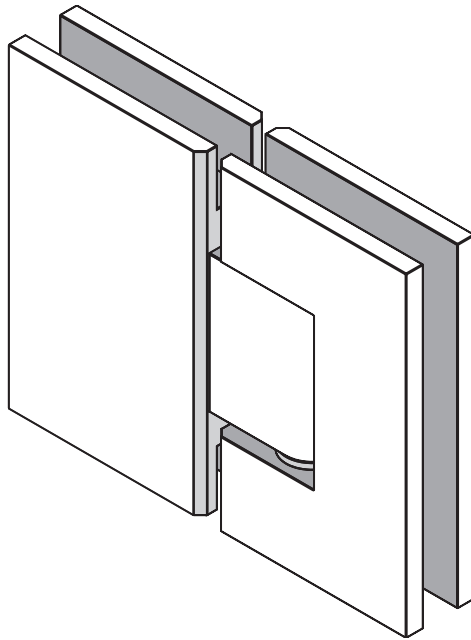

P A R  
TAPS

---



# Shower Hardware

Installation Guide

### Universal Shower Hinge - 180°

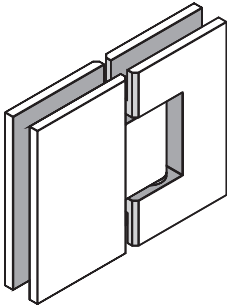

Max. door weight 35kg      Max. door width 800mm

Suitable for 10mm thick glass

### Glass Cut-Out Details

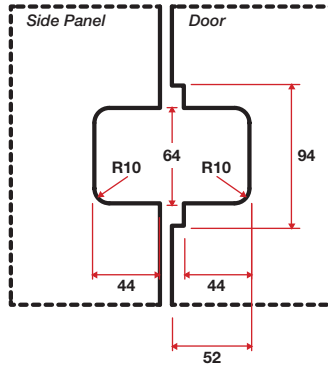

### Insitu Application

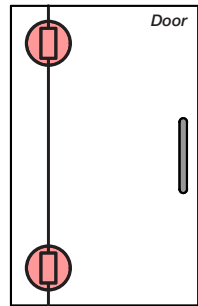

### Universal Shower Hinge - 90°

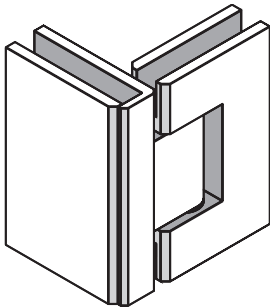

Max. door weight 35kg      Max. door width 800mm

Suitable for 10mm thick glass

### Glass Cut-Out Details

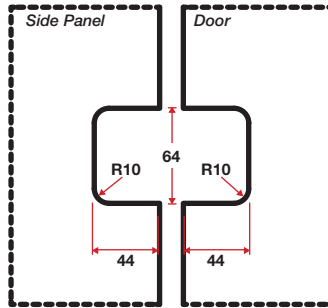

### Insitu Application

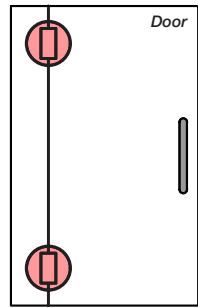

### Universal Shower Hinge - 90° Wall to Glass

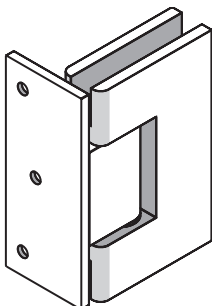

Max. door weight 35kg      Max. door width 800mm

Suitable for 10mm thick glass  
Stud fixing is recommended for all glass to wall applications

### Glass Cut-Out Details

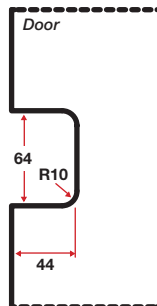

### Insitu Application

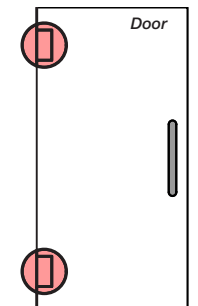

### Universal Shower Handle Round Dual Handle

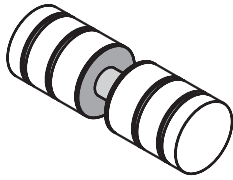

Suitable for 10mm thick glass

### Glass Cut-Out Details

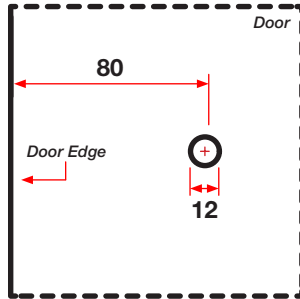

### Insitu Application

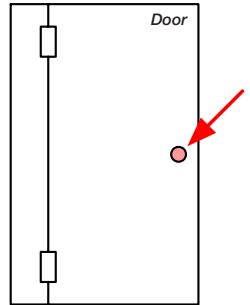

### Universal Shower Bracket - 90° Wall to Glass

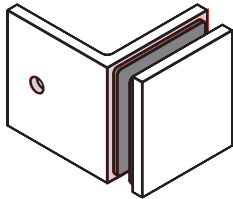

Suitable for 10mm thick glass

Stud fixing is recommended for all glass to wall applications

Ensure a 5mm gap between the wall and the door

### Glass Cut-Out Details

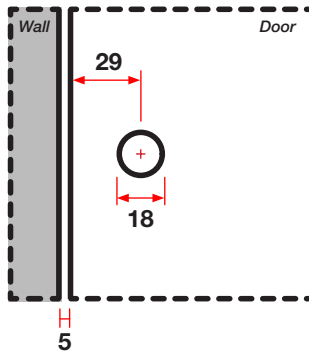



P A R  
TAPS



[www.partaps.com](http://www.partaps.com)



[/ParTapsPtyLtd](https://www.facebook.com/ParTapsPtyLtd)



[@par\\_taps](https://www.instagram.com/par_taps)