

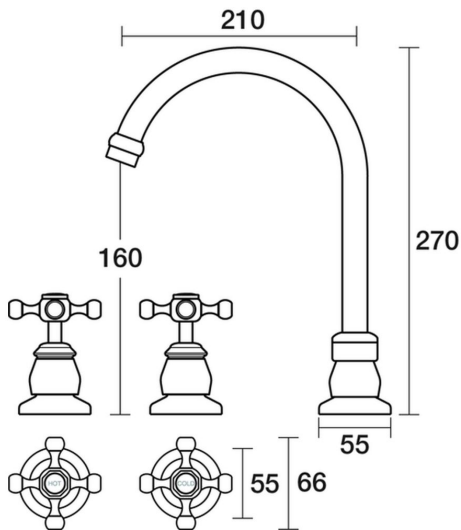

PAR  
TAPS



Tudor Spa Set Hob Swivel  
B31.061.1.01 - Chrome

- Solid brass construction
- Swivel outlet
- 1/2 Turn Ceramic Disc optional
- Designed & Handcrafted in Australia

### Finish Options

Chrome .01	Gold/Victorian Green .17	Native Brass .45
Brushed Chrome .02	Brushed Brass Gold .19	Luminick .47
Chrome/White .03	Brushed Rose Gold .21	Burnished .52
Chrome/Ivory .04	Gunmetal .23	Volcanic Grey .54
Chrome/Apricot .05	Brushed Gunmetal .24	Matt Gold .56
Chrome/Sienna Red .06	Brushed Nickel .25	Matt Nickel .57
Chrome/Victorian Green .07	Black Sapphire .26	Vintage Brass .67
Chrome/Gold .10	Satin Pearl .27	
Gold .11	Midnight Black .32	
Brushed Gold .12	Matt Black .34	
Gold/White .13	Brass Gold .38	
Gold/Ivory .14	Rumbled Brass .40	
Gold/Apricot .15	Brushed Brass .41	
Gold/Sienna Red .16	Brass .43	

For additional finishes or bespoke options, visit [our website](#) or [contact us](#).