

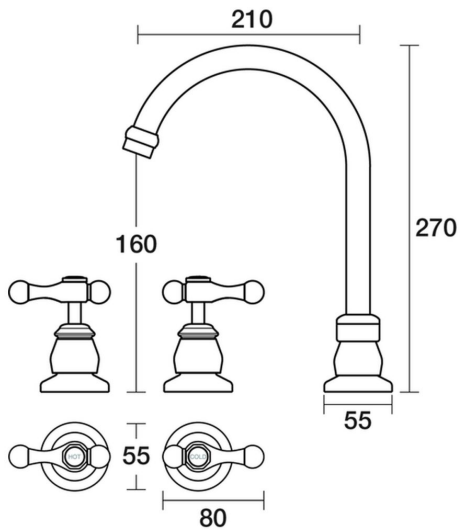





































PAR  
TAPS



Tudor Spa Set Hob Swivel Lever Ceramic Disc  
B31.061.3.01 - Chrome

- Solid brass construction
- Swivel outlet
- 1/2 Turn Ceramic Disc with lever handles
- Designed & Handcrafted in Australia

### Finish Options

 Chrome	.01	 Gold/Victorian Green	.17	 Native Brass	.45
 Brushed Chrome	.02	 Brushed Brass Gold	.19	 Luminick	.47
 Chrome/White	.03	 Brushed Rose Gold	.21	 Burnished	.52
 Chrome/Ivory	.04	 Gunmetal	.23	 Volcanic Grey	.54
 Chrome/Apricot	.05	 Brushed Gunmetal	.24	 Matt Gold	.56
 Chrome/Sienna Red	.06	 Brushed Nickel	.25	 Matt Nickel	.57
 Chrome/Victorian Green	.07	 Black Sapphire	.26	 Vintage Brass	.67
 Chrome/Gold	.10	 Satin Pearl	.27		
 Gold	.11	 Midnight Black	.32		
 Brushed Gold	.12	 Matt Black	.34		
 Gold/White	.13	 Brass Gold	.38		
 Gold/Ivory	.14	 Rumbled Brass	.40		
 Gold/Apricot	.15	 Brushed Brass	.41		
 Gold/Sienna Red	.16	 Brass	.43		

For additional finishes or bespoke options, visit [our website](#) or [contact us](#).